



Flashings and Trims

Flashings and trims come in 10 ft. lengths and are available in plain galvanized, galvalume and in galvanized pre-painted steel in over 30 attractive colours. Standard gauge thickness used is 30 ga. (.015") but our flashings and trims shown in this brochure are standard but can be modified to customer specifications.

ROOFING FLASHINGS

NOTE: USE THE #205 WALL FLASHING AND THE #210 COTTAGE ROOF CAP FOR THE "SECURITY" RIB, "POCKET" RIB, "AMERI-CANA" PANEL AND "FUNDY" PANEL.

#201

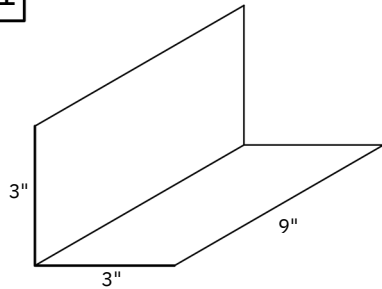

STEP FLASHING (6" X 9")
(50 PCS PER BUNDLE) (MIXED COLOURS)

#203

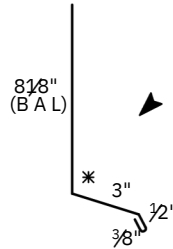

LARGE WALL OR CHIMNEY FLASHING TYPE S
(12" GIRTH) * SPECIFY PITCH

#205

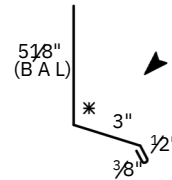

WALL FLASHING TYPE S
(9" GIRTH) * SPECIFY PITCH

#206

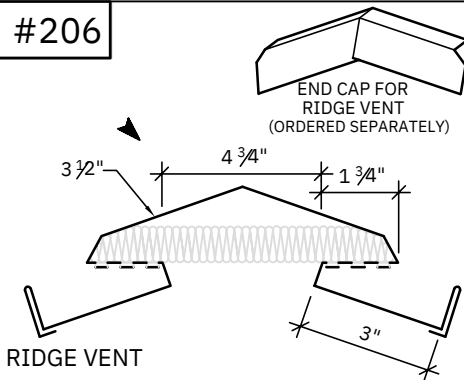

RIDGE VENT

#207

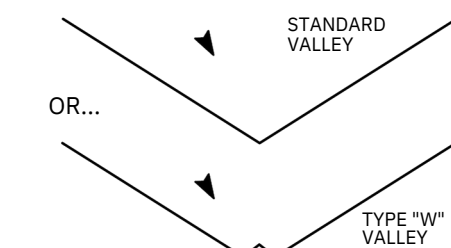

VALLEY 18", 24" AND 36"

#208

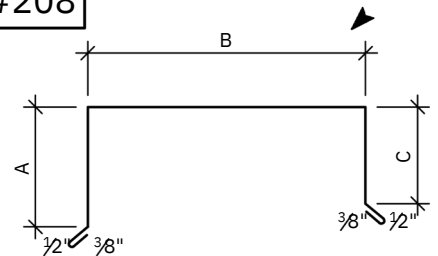

CAP FLASHING
(A + B + C + 3/4" = GIRTH)

#209

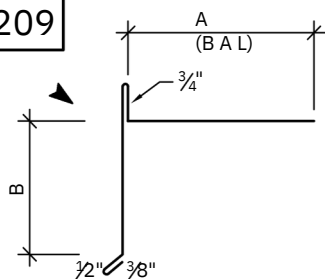

GRAVEL STOP
(A + B + 3/8" = GIRTH)

#210

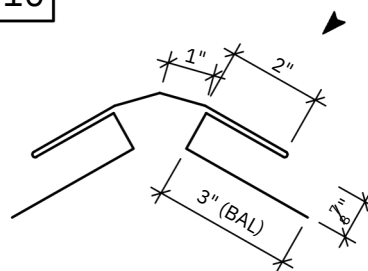

COTTAGE ROOF CAP
(18" GIRTH)

#211

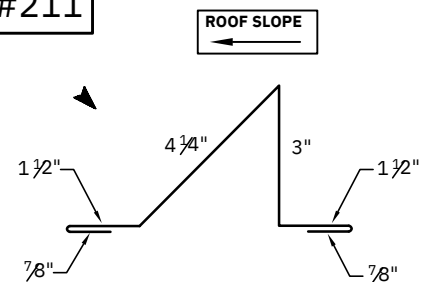

SNOW GUARD
(12" GIRTH) MINIMUM 26g (.021") RECOMMENDED

#212

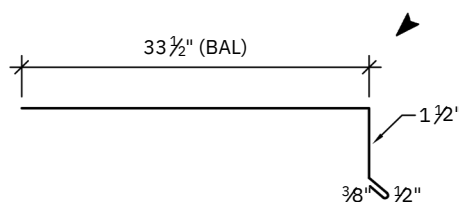

ICE APRON
(for shingles)
(36" GIRTH)

#213 TYPE 1

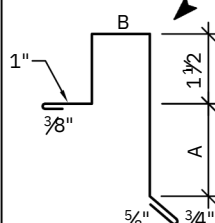

GABLE END CAP FOR "HERITAGE" PROFILE
(A+B+5 3/4" = GIRTH)

#213 TYPE 2

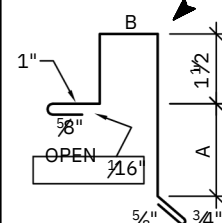

GABLE END CAP FOR "HERITAGE" PROFILE
(A+B+6" = GIRTH)

#214

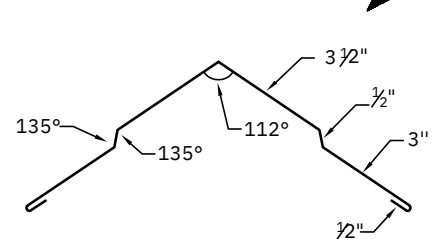

LIBERTY RIDGE CAP
(15" GIRTH)

FLASHINGS AND MOULDINGS FOR SIDING

NOTE: THE "300 SERIES" FLASHINGS & MOULDINGS MAY BE USED WITH THE FOLLOWING PROFILES.

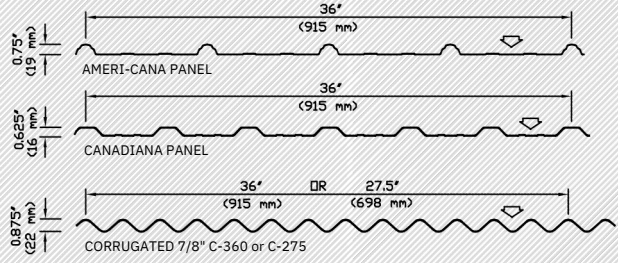
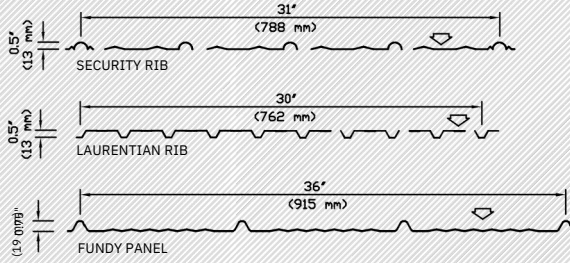

#301

X=Profile opening

PROFILES:

- (a) Laurentian $\frac{5}{8}$ "
- (b) Corrugated 1 "
- (c) Security $\frac{5}{8}$ "
- (d) Ameri-Cana, Canadiana and Fundy $\frac{7}{8}$ "

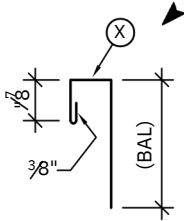

"J" TRIM
(5" GIRTH)

#302

X=Profile opening

PROFILES:

- (a) Laurentian $\frac{5}{8}$ "
- (b) Corrugated 1 "
- (c) Security $\frac{5}{8}$ "
- (d) Ameri-Cana, Canadiana and Fundy $\frac{7}{8}$ "

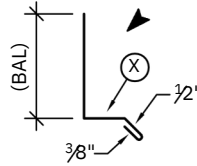

BASE FLASHING
(4" GIRTH)

#303

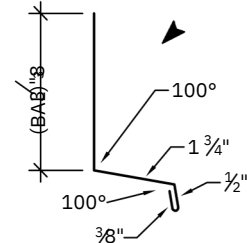

WINDOW & DOOR FLASHING
(6" GIRTH)

#304

X=Profile opening

PROFILES:

- (a) Laurentian $\frac{5}{8}$ "
- (b) Corrugated 1 "
- (c) Security $\frac{5}{8}$ "
- (d) Ameri-Cana, Canadiana and Fundy $\frac{7}{8}$ "

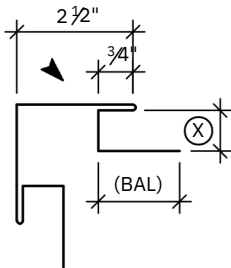

OUTSIDE CORNER
(12" GIRTH)

#305

X=Profile opening

PROFILES:

- (a) Laurentian $\frac{5}{8}$ "
- (b) Corrugated 1 "
- (c) Security $\frac{5}{8}$ "
- (d) Ameri-Cana, Canadiana and Fundy $\frac{7}{8}$ "

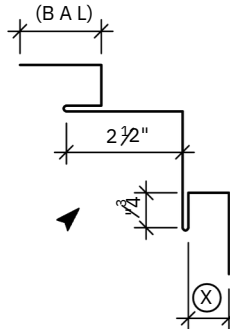

INSIDE CORNER
(12" GIRTH)

#306

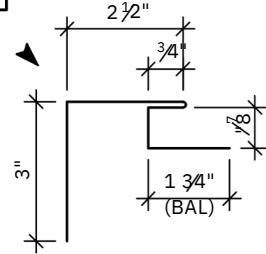

HALF CORNER
(9" GIRTH)

#307

X=Profile opening

PROFILES:

- (a) Laurentian $\frac{5}{8}$ "
- (b) Corrugated 1 "
- (c) Security $\frac{5}{8}$ "
- (d) Ameri-Cana, Canadiana and Fundy $\frac{7}{8}$ "

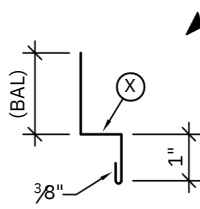

GABLE DIVIDER
(4" GIRTH)

#308

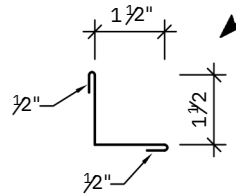

"L" TRIM
(4" GIRTH)

#309

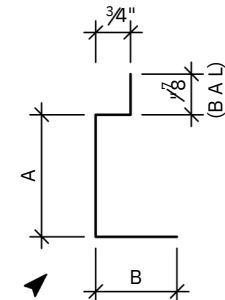

WINDOW CASING FLASHING
(A + B + 3/8" GIRTH)

#310

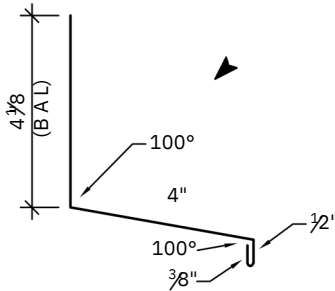

BRICK FLASHING
(9" GIRTH)

#311

X=Profile opening

PROFILES:

- (a) Laurentian $\frac{5}{8}$ "
- (b) Corrugated 1 "
- (c) Security $\frac{5}{8}$ "
- (d) Ameri-Cana, Canadiana and Fundy $\frac{7}{8}$ "

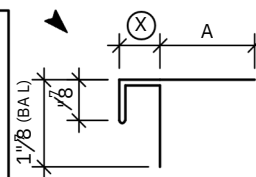

WINDOW & DOOR JAMB
(2X + A + 3 5/8" = GIRTH)

#312

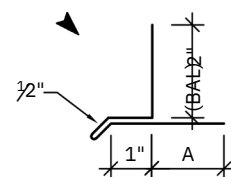

WINDOW & DOOR FLASHING
(5" + A = GIRTH)

FLASHINGS AND MOULDINGS FOR SIDING (continue)

#313

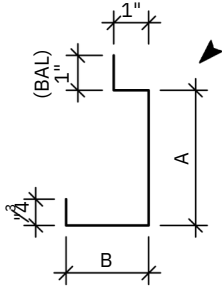

SLIDING DOOR EDGE TRIM
(A + B + 3/4" GIRTH)

#314

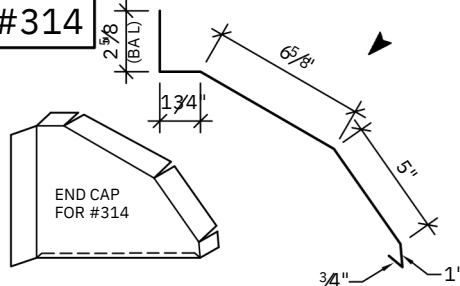

COVER FOR DOUBLE ROUND DOOR TRACK
(18" GIRTH)

#315

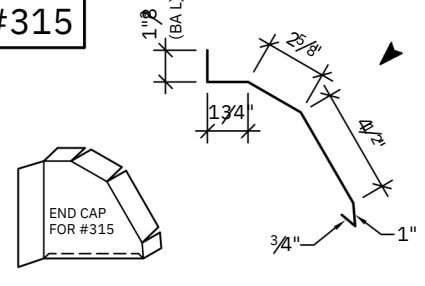

COVER FOR SINGLE ROUND DOOR TRACK
(12" GIRTH)

#316

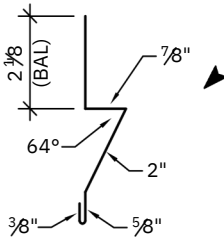

ANGLED BASE FLASHING
(6" GIRTH)

#317

X=Profile opening
Y=Profile opening

PROFILES:

- (a) Laurentian 5/8" X 1"
- (b) Corrugated 5/8" X 1"
- (c) Security 5/8" X 7/8"
- (d) Ameri-Cana, Canadiana and Fundy 5/8" X 7/8"

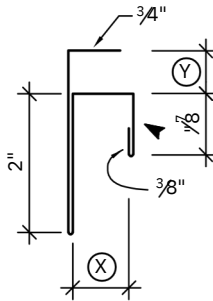

"F-J" TRIM
(X + Y + 6" = GIRTH)

#318

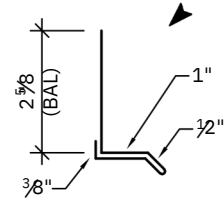

WINDOW & DOOR FLASHING
(6" GIRTH)

FLASHINGS FOR EAVES & GABLE ENDS

#401

VENTED AT EXTRA COST

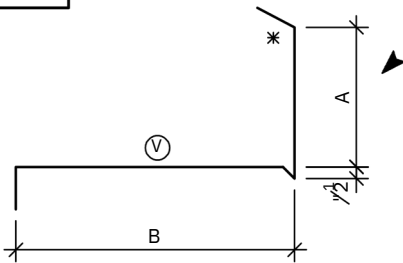

FASCIA AND SOFFIT: TYPE 1
(A+B+5" = GIRTH) * SPECIFY PITCH

#402

VENTED AT EXTRA COST

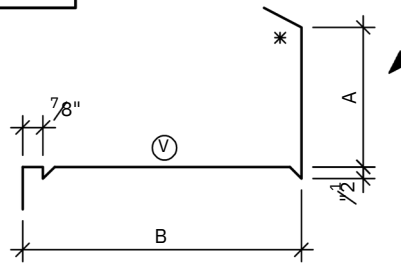

FASCIA AND SOFFIT: TYPE 1J
(A+B+5" = GIRTH) * SPECIFY PITCH

#404

VENTED AT EXTRA COST

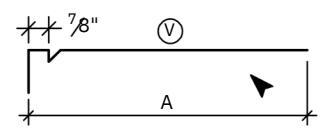

SINGLE SOFFIT:
TYPE 1J
(A+3" = GIRTH)

#408

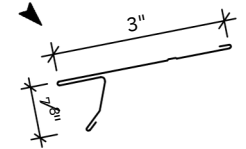

STARTER
FOR SHINGLES
(5" GIRTH)

#405

VENTED AT EXTRA COST

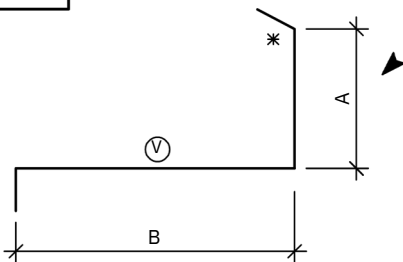

FASCIA AND SOFFIT: TYPE 2
(A+B+4" = GIRTH) * SPECIFY PITCH

#406

VENTED AT EXTRA COST

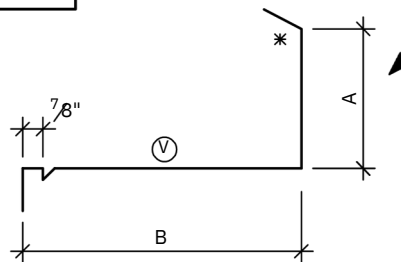

FASCIA AND SOFFIT: TYPE 2J
(A+B+5" = GIRTH) * SPECIFY PITCH

#409

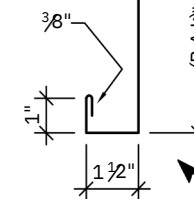

FASCIA: TYPE 1
(9" GIRTH)

#410

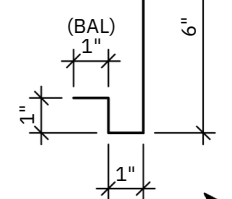

FASCIA: TYPE 2
(9" GIRTH)

#411

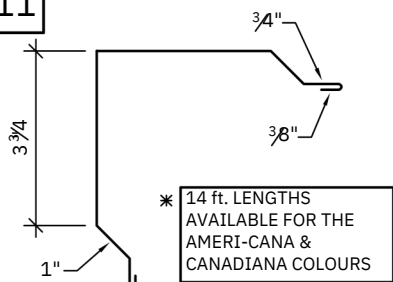

RAKE EDGE TRIM
(12" GIRTH) (10 or 14 ft. LENGTHS) *

#412

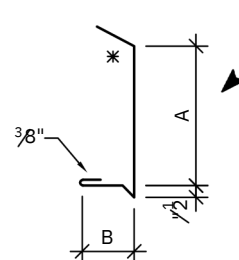

SPECIAL FASCIA
(A+B+3" = GIRTH) (B=MIN. 1 1/2") * SPECIFY PITCH

#414

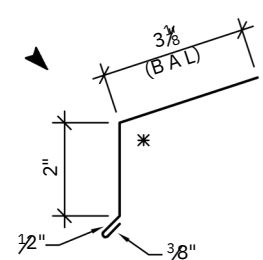

STEEL ROOFING DRIP EDGE
(6" GIRTH) * SPECIFY PITCH

FLASHINGS FOR EAVES & GABLE ENDS (continue)

#415

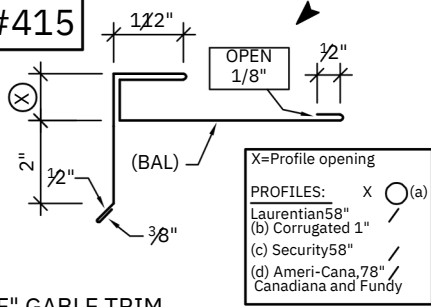

"F" GABLE TRIM
(12" GIRTH) (AVAILABLE IN 30G, 28G or 26G)

#416

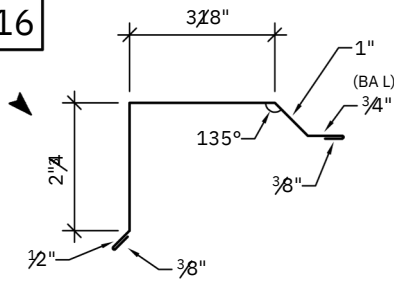

GABLE END CAP
(9" GIRTH)

#417

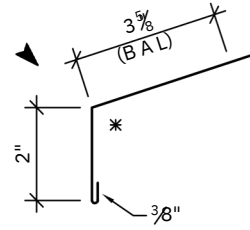

GUTTER APRON
(6" GIRTH) * SPECIFY PITCH

"COLONIAL SIDING"

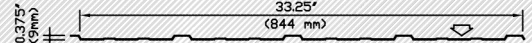

#501

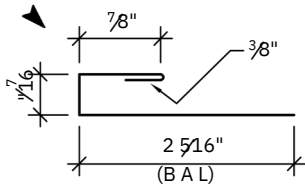

COLONIAL "J" TRIM
(4" GIRTH)

#502

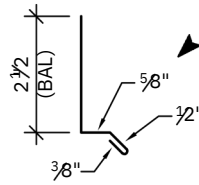

COLONIAL BASE FLASHING
(4" GIRTH)

#503

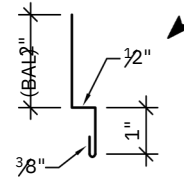

COLONIAL GABLE DIVIDER
(4" GIRTH)

#504

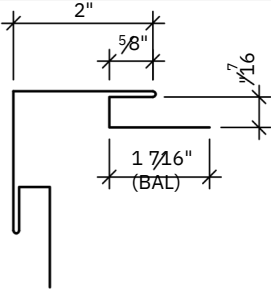

COLONIAL OUTSIDE CORNER
(9" GIRTH)

#505

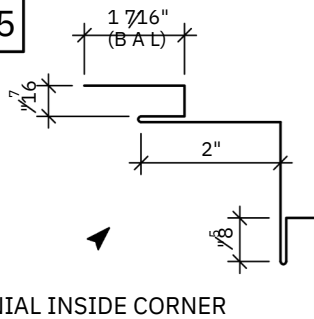

COLONIAL INSIDE CORNER
(9" GIRTH)

#518

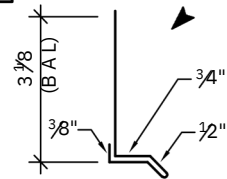

COLONIAL WINDOW & DOOR FLASHING
(6" GIRTH)

"COMMERCIAL RIB"

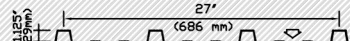

#601

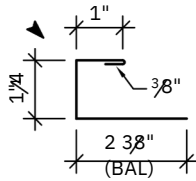

COMMERCIAL "J" TRIM
(5" GIRTH)

#602

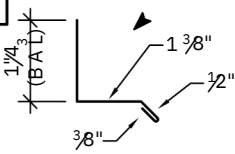

COMMERCIAL BASE FLASHING
(4" GIRTH)

"R-PANEL"

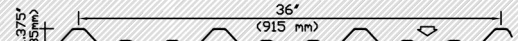

#R601

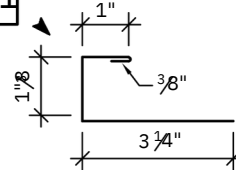

"J" TRIM
(6" GIRTH)

#R602

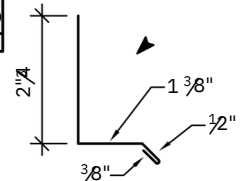

BASE FLASHING
(5" GIRTH)

#603

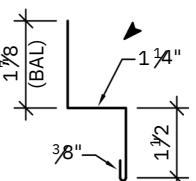

COMMERCIAL GABLE DIVIDER
(5" GIRTH)

#604

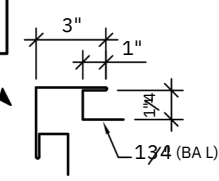

COMMERCIAL OUTSIDE CORNER
(14" GIRTH)

#R603

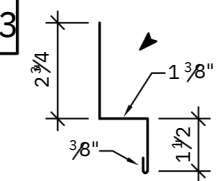

GABLE DIVIDER
(6" GIRTH)

#R604

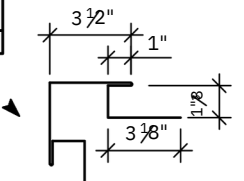

OUTSIDE CORNER
(18" GIRTH)

#605

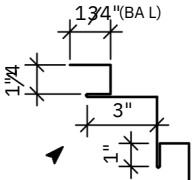

COMMERCIAL INSIDE CORNER
(14" GIRTH)

#610

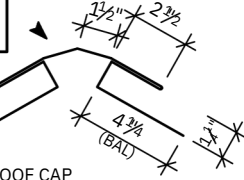

COTTAGE ROOF CAP FOR COMMERCIAL RIB PROFILE
(24" GIRTH)

#R605

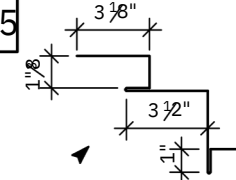

INSIDE CORNER
(18" GIRTH)

#R610

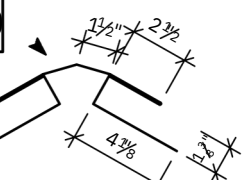

COTTAGE ROOF CAP
(24" GIRTH)

INDUSTRIAL PROFILES (100 SERIES)

NOTE:
THE "100 SERIES"
FLASHINGS & TRIMS MAY
BE USED WITH THE
FOLLOWING PROFILES.

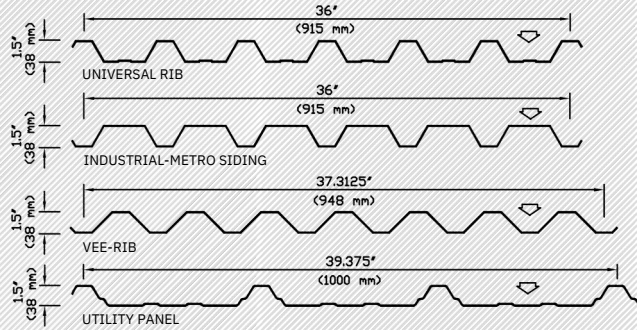

#101

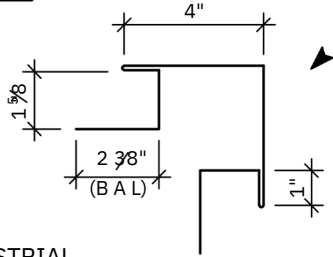

INDUSTRIAL
OUTSIDE CORNER
(18" GIRTH)

#102

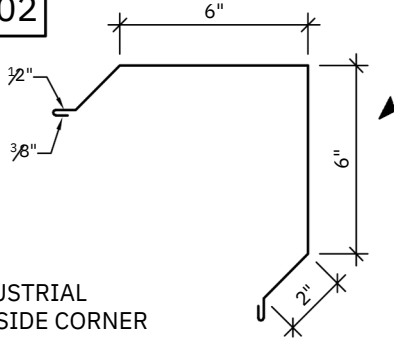

INDUSTRIAL
OUTSIDE CORNER
(18" GIRTH)

#103

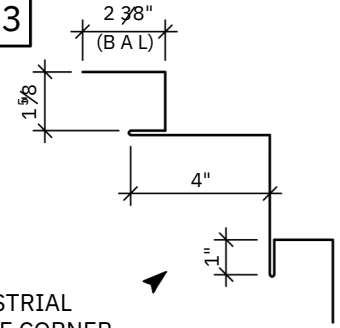

INDUSTRIAL
INSIDE CORNER
(18" GIRTH)

#104

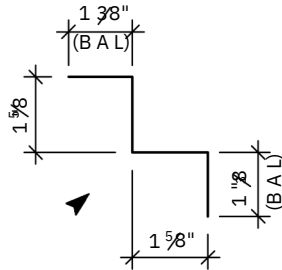

INDUSTRIAL
INSIDE CORNER
(6" GIRTH)

#105

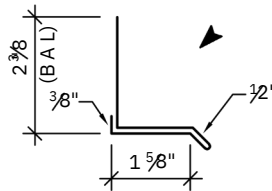

INDUSTRIAL
WINDOW & DOOR FLASHING
(7" GIRTH)

#106

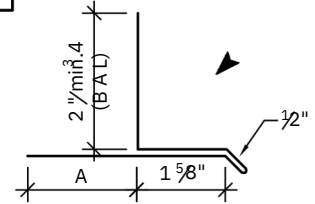

INDUSTRIAL
WINDOW & DOOR FLASHING
(A + 7" = GIRTH)

#107

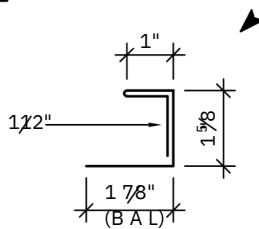

INDUSTRIAL "J" TRIM
(7" GIRTH)

#108

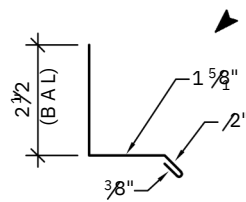

INDUSTRIAL BASE FLASHING
(5" GIRTH)

#109

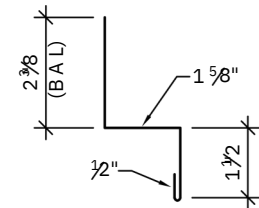

INDUSTRIAL GABLE DIVIDER
(6" GIRTH)

#110

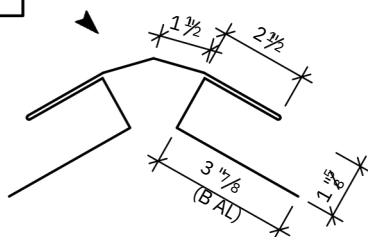

COTTAGE ROOF CAP
FOR INDUSTRIAL PROFILE
(24" GIRTH)

#111

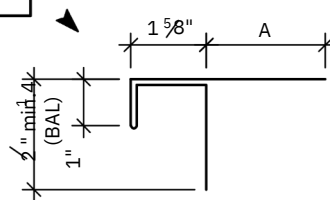

INDUSTRIAL DOOR & WINDOW JAMB
(A + 7.7/2" = GIRTH)

"URBAN ACCENT" SERIES

NOTE: MOST OF THE "100 SERIES" INDUSTRIAL FLASHINGS & TRIMS MAY BE USED WITH THE **URBAN ACCENT** SERIES.

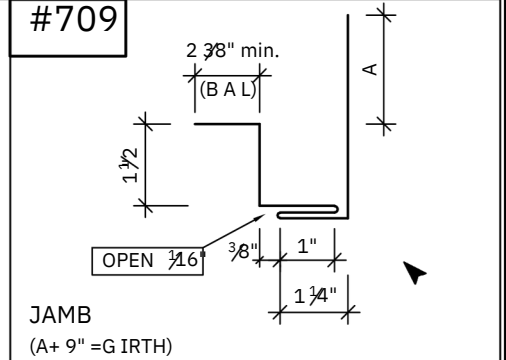
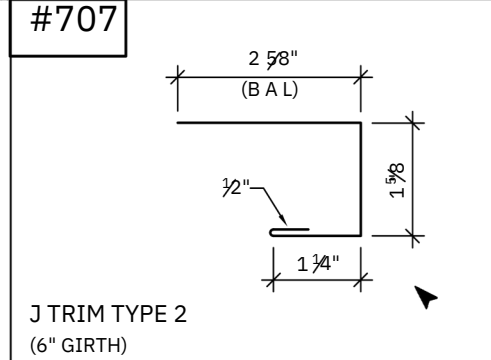
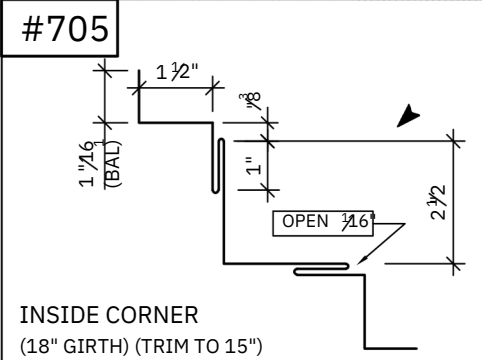
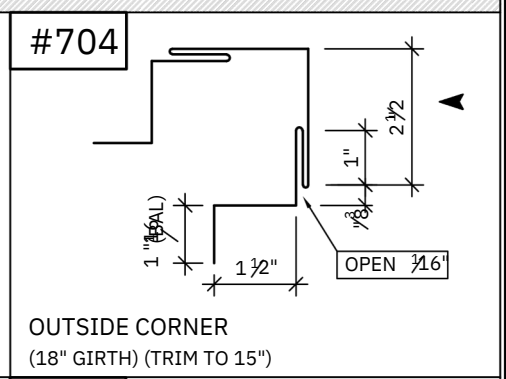
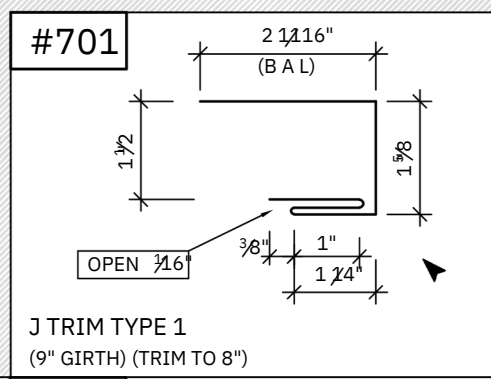
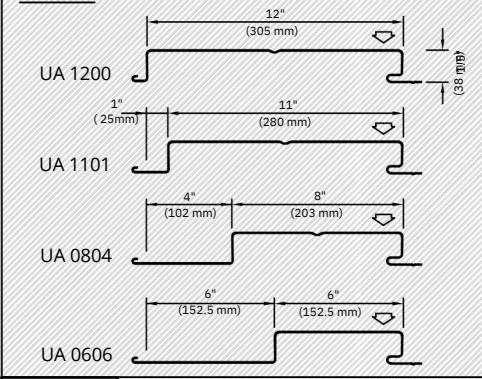

"HERITAGE SERIES" & "JUNIOR HF"

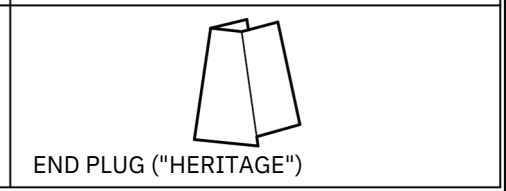
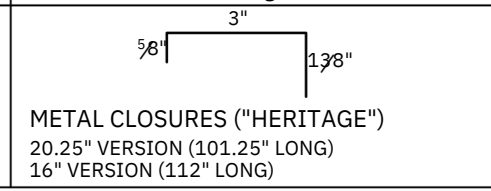
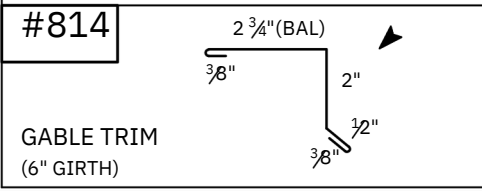
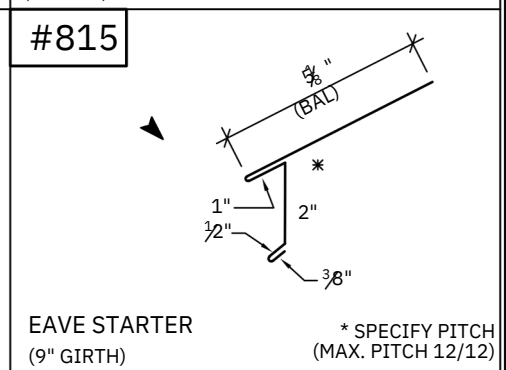
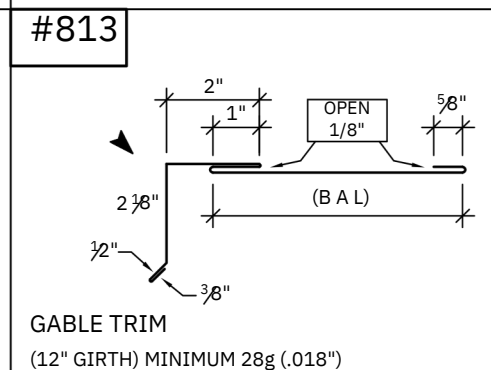
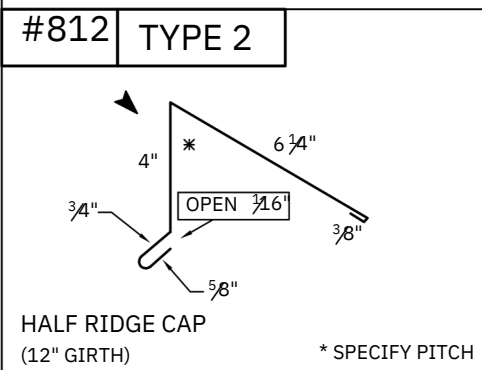
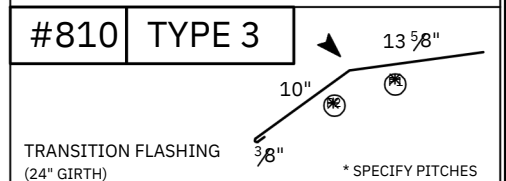
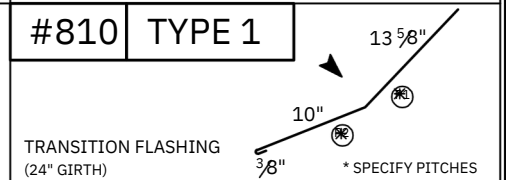
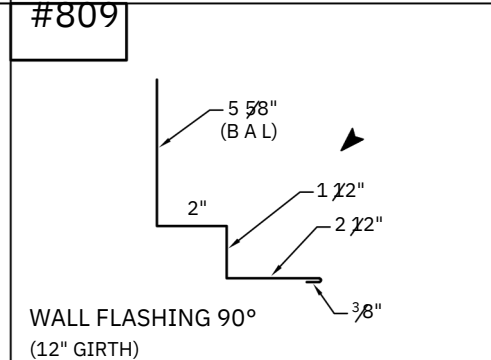
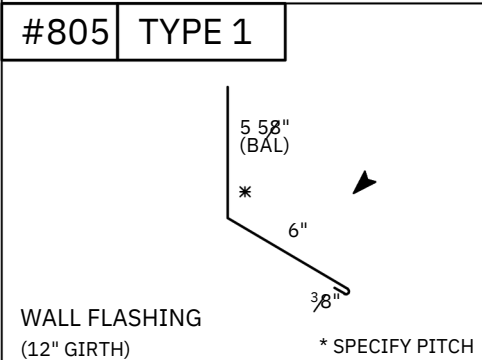
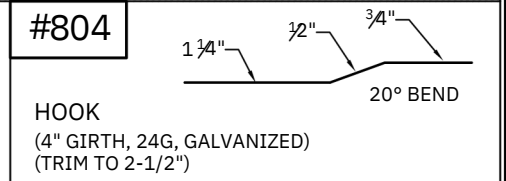
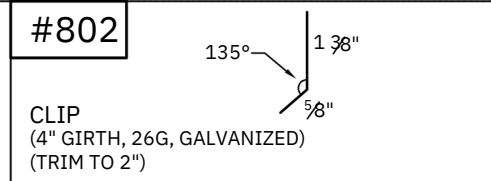

"MONTECIANO" STEEL TILE



<p>#901</p> <p>"J" CLOSURE (10" GIRTH, 24G, GALVANIZED)</p>	<p>#902</p> <p>"L" BAR (6" GIRTH, 28G, GALVANIZED)</p>	<p>#909</p> <p>VALLEY CAP (12" GIRTH, 29G)</p> <p>* SPECIFY PITCH</p>	<p>#914</p> <p>RIDGE CAP BASE (12" GIRTH, 29G)</p> <p>* SPECIFY PITCH</p>
--	---	--	--

"GALANTA" SIDING

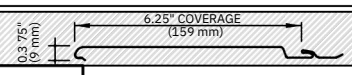

<p>#G01</p> <p>"J" TRIM (4" GIRTH, 26g)</p>	<p>#G02</p> <p>BASE FLASHING (4" GIRTH, 26g)</p>	<p>#G03</p> <p>STAR TER (4" GIRTH, 26g, GALVANIZED)</p>	<p>#G04</p> <p>OUTSIDE CORNER (8 1/8" GIRTH, 26g)</p>
<p>#G05</p> <p>INSIDE CORNER (8 1/8" GIRTH, 26g)</p>	<p>#G07</p> <p>GABLE DIVIDER (4" GIRTH, 26g)</p>	<p>#G08</p> <p>PERFORATED "L" CLOSURE (4" GIRTH) (TRIM TO 2")</p>	<p>#G09</p> <p>"Z" SUPPORT (4" GIRTH, 26g, GALVANIZED) (TRIM TO 3")</p>
<p>#G11</p> <p>WINDOW & DOOR JAMB (4 1/4" + A = GIRTH (8 1/8" max.), 26g)</p>	<p>#G12</p> <p>NOTE: A = 4 7/8" max.</p> <p>WINDOW & DOOR FLASHING (4" + A = GIRTH (8 1/8" max.), 26g)</p>	<p>#G17</p> <p>SIDING / SOFFIT "F-J" TRIM (8 1/8" GIRTH, 26g)</p>	<p>#G18</p> <p>WINDOW & DOOR FLASHING (4" GIRTH, 26g)</p>
<p>#G19A</p> <p>VERTICAL DIVIDER (Part "A") (5" GIRTH, 26g)</p>	<p>#G19B</p> <p>VERTICAL DIVIDER (Part "B") (4" GIRTH, 26g) (TRIM TO 3")</p>	<p>VERTICAL DIVIDER (Parts "A" & "B" assembled)</p>	

<p>HEAVY GAUGE FIXATION</p>	<p>"U" CHANNEL AVAILABLE IN 20 GA, 18 GA AND 16 GA. GIRTHS AVAILABLE: 4", 5", 6", 7", 8", 9", 12", 18", 24" (GIRTH = A + B + C) NOTE: Measurements subject to machine capacities</p>
	<p>"Z" BAR AVAILABLE IN 20 GA, 18 GA AND 16 GA. GIRTHS AVAILABLE: 4", 5", 6", 7", 8", 9", 12", 18", 24" (GIRTH = A + B + C) A: min. 1" B: min. 1" C: min. 1"</p>
	<p>"OMEGA" BAR AVAILABLE IN 20 GA, 18 GA AND 16 GA. GIRTHS AVAILABLE: 4", 5", 6", 7", 8", 9", 12", 18", 24" GIRTH = (A x 2) + (B x 2) + C A: min. 1" B: min. 1" (H): Perpendicular height NOTE: B = (H) x 1.155</p>